

FYH

NEW STAINLESS

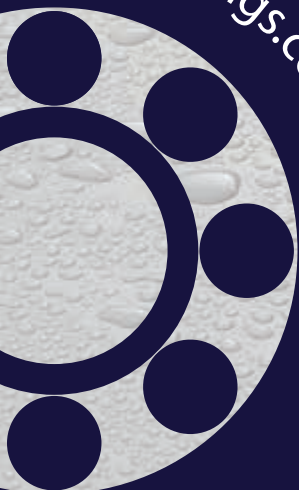

fyhbearings.com



UCSP-S6
Cylindrical bore (with set screws)
d 12 ~ 65 mm

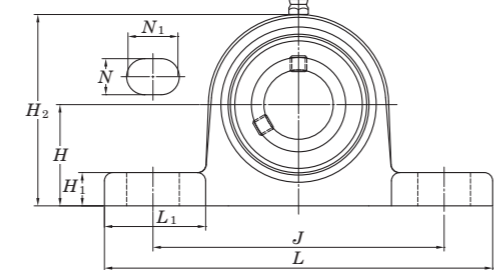
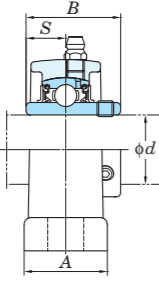

With Pressed Stainless Steel Cover

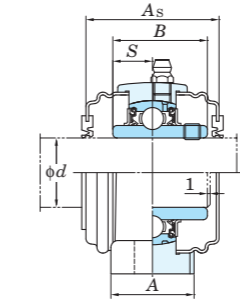

With Plastic Cover

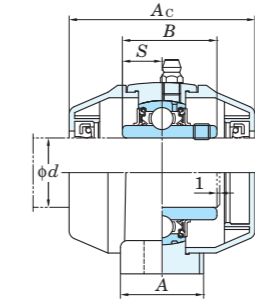

Variations of tolerance of distance from mounting bottom to center of spherical bore (ΔH_s)

Housing No.	ΔH_s
SP203~SP210	±0.15
SP211~SP213	±0.2

Unit: mm

Shaft Dia. mm inch d	Dimensions inch mm												Bolt Size inch mm	Standard			Basic Load Ratings kN C_r C_{0r}	Factor f_0	With Pressed Stainless Steel Cover			With Plastic Cover										
	H	L	A	J	N	N_1	H_1	H_2	L_1	B	S	Unit No.		Housing No.	Bearing No.	Mass kg			Open Type Unit No.	One Side Closed Type Unit No.	Dimension mm inch A_s	Mass kg	Open Type Unit No.	One Side Closed Type Unit No.	Dimension mm inch A_c	Mass kg						
12 1/2	1 3/16	5	1 3/16	3 3/4	1/2	23/32	7/16	2 7/32	1 15/32	1.079	0.453	3/8	UCSP201XS6 UCSP201-8XS6	SP203	UC201XS6 UC201-8XS6	0.47	8.15	3.85	13.2	-	-	-	-	-	-	-	-	-	-	-	-	-
15 5/8	30.2	127	30	95	13	18	11	56	37.5	27.4	11.5	M10	UCSP202XS6 UCSP202-10XS6	SP203	UC202XS6 UC202-10XS6	0.47	8.15	3.85	13.2	-	-	-	-	-	-	-	-	-	-	-	-	-
17													UCSP203XS6		UC203XS6																	
20 3/4	1 5/16	5	1 3/16	3 3/4	1/2	23/32	7/16	2 15/32	1 19/64	1.220	0.500	3/8	UCSP204-12S6 UCSP204S6	SP204	UC204-12S6 UC204S6	0.6	10.9	5.35	13.2	UCSP204CS6	UCSP204CDS6	45	1 25/32	0.6	UCSP204VCS6	UCSP204VCD6	62	2 7/16	0.6			
25 7/8 15/16	1 7/16	5 1/2	1 3/16	4 1/8	1/2	3/4	15/32	2 23/32	1 7/16	1.343	0.563	3/8	UCSP205-14S6 UCSP205-15S6 UCSP205S6	SP205	UC205-14S6 UC205-15S6 UC205S6	0.7	11.9	6.30	13.9	UCSP205CS6	UCSP205CDS6	49	1 15/16	0.7	UCSP205VCS6	UCSP205VCD6	68	2 43/64	0.7			
25													UCSP205-16S6		UC205-16S6																	
30 1 1/8	1 11/16	6 1/2	1 13/32	4 3/4	2 1/32	13/16	1/2	3 3/16	1 23/32	1.500	0.626	1/2	UCSP206-18S6 UCSP206S6	SP206	UC206-18S6 UC206S6	1.1	16.5	9.05	13.9	UCSP206CS6	UCSP206CDS6	53	2 3/32	1.1	UCSP206VCS6	UCSP206VCD6	80	3 5/32	1.1			
30													UCSP206-19S6 UCSP206-20S6		UC206-19S6 UC206-20S6																	
35 1 1/4 1 5/16 1 3/8	1 7/8	6 9/16	1 1/2	5	2 1/32	13/16	9/16	3 19/32	1 17/32	1.689	0.689	1/2	UCSP207-20S6 UCSP207-21S6 UCSP207-22S6	SP207	UC207-20S6 UC207-21S6 UC207-22S6	1.4	21.8	12.3	13.9	UCSP207CS6	UCSP207CDS6	60	2 3/8	1.4	UCSP207VCS6	UCSP207VCD6	87	3 27/64	1.4			
35													UCSP207S6		UC207S6																	
35													UCSP207-23S6		UC207-23S6																	
40 1 1/2 1 9/16	1 15/16	7 1/4	1 9/16	5 13/32	2 1/32	13/16	9/16	3 13/16	1 11/16	1.937	0.748	1/2	UCSP208-24S6 UCSP208-25S6	SP208	UC208-24S6 UC208-25S6	1.7	24.8	14.3	14.0	UCSP208CS6	UCSP208CDS6	69	2 23/32	1.7	UCSP208VCS6	UCSP208VCD6	98	3 55/64	1.7			
40													UCSP208S6		UC208S6																	
45 1 5/8 1 11/16 1 3/4	2 1/8	7 15/32	1 9/16	5 3/4	2 1/32	13/16	19/32	4 3/32	1 47/64	1.937	0.748	1/2	UCSP209-26S6 UCSP209-27S6 UCSP209-28S6	SP209	UC209-26S6 UC209-27S6 UC209-28S6	2	27.8	16.2	14.0	UCSP209CS6	UCSP209CDS6	69	2 23/32	2.0	UCSP209VCS6	UCSP209VCD6	107	4 7/32	2.0			
45													UCSP209S6		UC209S6																	
50 1 7/8 1 15/16	2 1/4	8 1/8	1 25/32	6 1/4	2 5/32	7/8	5/8	4 3/8	1 7/8	2.031	0.748	5/8	UCSP210-30S6 UCSP210-31S6	SP210	UC210-30S6 UC210-31S6	2.5	29.8	18.6	14.4	UCSP210CS6	UCSP210CDS6	74	2 29/32	2.5	UCSP210VCS6	UCSP210VCD6	120	4 23/32	2.5			
50													UCSP210S6		UC210S6																	
55 2 2 1/8	2 1/2	8 5/8	1 7/8	6 23/32	2 5/32	7/8	5/8	4 29/32	1 55/64	2.189	0.874	5/8	UCSP211-32S6 UCSP211-34S6	SP211	UC211-32S6 UC211-34S6	3.4	36.8	23.5	14.4	UCSP211CS6	UCSP211CDS6	75	2 15/16	3.4	UCSP211VCS6	UCSP211VCD6	129	5 5/64	3.4			
55													UCSP211S6		UC211S6																	
55													UCSP211-35S6		UC211-35S6																	
60 2 3/8 2 7/16	2 3/4	9 1/2	2 5/32	7 1/4	2 5/32	3 1/32	2 1/32	5 7/16	2 1/32	2.563	1.000	5/8	UCSP212-36S6 UCSP212S6	SP212	UC212-36S6 UC212S6	4.5	44.5	29	14.4	UCSP212CS6	UCSP212CDS6	88	3 15/32	4.5	UCSP212VCS6	UCSP212VCD6	140	5 33/64	4.5			
60													UCSP212-38S6 UCSP212-39S6		UC212-38S6 UC212-39S6																	
65 2 1/2	3	10 7/16	2 1/4	8	3 1/32	1 9/64	13/16	5 29/32	2 9/32	2.563	1.000	5/8	UCSP213-40S6 UCSP213S6	SP213	UC213-40S6 UC213S6	5.58	48.2	32.1	14.4	UCSP213CS6	UCSP213CDS6	89	3 1/2	5.6	UCSP213VCS6	UCSP213VCD6	150	5 29/32	5.6			

Remarks 1. In Part No. of unit and units with covers, fitting codes follow bore diameter numbers.
2. Part No. of applicable grease fittings are shown below.
A-1/4-28UNFN13 201X~210
A-R1/8N13..... 211~213
3. For the dimensions and forms of applicable bearings, see the dimensional tables of ball bearing for unit.

UCSPA-S6
Cylindrical bore (with set screws)
d 12 ~ 50 mm

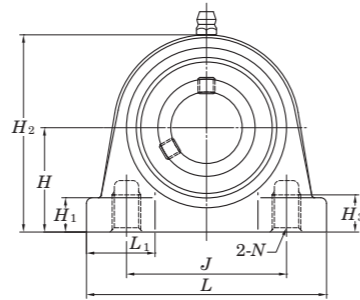
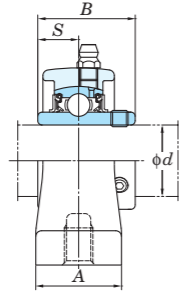

With Pressed Stainless Steel Cover

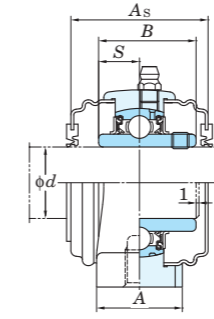

With Plastic Cover

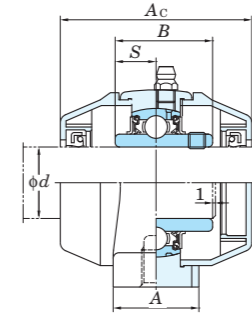

Variations of tolerance of distance from mounting bottom to center of spherical bore (ΔH_s) and variations of tolerance of distance between centers of bolt holes (ΔJ_s)

Housing No.	ΔH_s	ΔJ_s
SPA203~SPA210	± 0.15	± 0.5

Unit: mm

Shaft Dia mm inch d	Dimensions inch mm												Unit No.	Standard Housing No.	Bearing No.	Mass kg	Basic Load Ratings kN C_r C_{0r}	Factor f_0	With Pressed Stainless Steel Cover			With Plastic Cover								
	H	L	A	J	N	H ₁	H ₂	H ₃	L ₁	B	S	Open Type							One Side Closed Type	Dimension mm inch A _s	Mass kg	Open Type	One Side Closed Type	Dimension mm inch A _c	Mass kg					
12 1/2	1 3/16	3	1 3/16	2 3/64	M10x1.5	13/32	2 1/4	33/64	7/8	1.079	0.453	UCSPA201XS6 UCSPA201-8XS6 UCSPA202XS6 UCSPA202-10XS6 UCSPA203XS6	SPA203	UC201XS6 UC201-8XS6 UC202XS6 UC202-10XS6 UC203XS6	0.43	8.15	3.85	13.2	-	-	-	-	-	-	-	-	-	-	-	-
15 5/8	30.2	76	30	52	M10x1.5	10	57	13	22	27.4	11.5	UCSPA204-12S6 UCSPA204S6	SPA204	UC204-12S6 UC204S6	0.47	10.9	5.35	13.2	UCSPA204CS6	UCSPA204CDS6	45	1 25/32	0.47	UCSPA204VCS6	UCSPA204VCDS6	62	2 7/16	0.47		
17	1 3/16	3	1 3/16	2 3/64	M10x1.5	13/32	2 3/8	33/64	7/8	1.220	0.500	UCSPA205-14S6 UCSPA205-15S6 UCSPA205S6 UCSPA205-16S6	SPA205	UC205-14S6 UC205-15S6 UC205S6 UC205-16S6	0.63	11.9	6.30	13.9	UCSPA205CS6	UCSPA205CDS6	49	1 15/16	0.63	UCSPA205VCS6	UCSPA205VCDS6	68	2 43/64	0.63		
20 3/4	30.2	76	30	52	M10x1.5	10	60	13	22	31	12.7	UCSPA206-18S6 UCSPA206S6 UCSPA206-19S6 UCSPA206-20S6	SPA206	UC206-18S6 UC206S6 UC206-19S6 UC206-20S6	0.91	16.5	9.05	13.9	UCSPA206CS6	UCSPA206CDS6	53	2 3/32	0.91	UCSPA206VCS6	UCSPA206VCDS6	80	3 5/32	0.91		
25 7/8 15/16 1	1 7/16	3 5/16	1 3/16	2 13/64	M10x1.5	15/32	2 23/32	33/64	15/16	1.343	0.563	UCSPA207-20S6 UCSPA207-21S6 UCSPA207-22S6 UCSPA207S6 UCSPA207-23S6	SPA207	UC207-20S6 UC207-21S6 UC207-22S6 UC207S6 UC207-23S6	1.3	21.8	12.3	13.9	UCSPA207CS6	UCSPA207CDS6	60	2 3/8	1.3	UCSPA207VCS6	UCSPA207VCDS6	87	3 27/64	1.3		
30 1 1/8 1 3/16 1 1/4	1 11/16	3 11/16	1 13/32	2 19/32	M14x2	15/32	3 3/16	45/64	1 3/32	1.500	0.626	UCSPA208-24S6 UCSPA208-25S6 UCSPA208S6	SPA208	UC208-24S6 UC208-25S6 UC208S6	1.6	24.8	14.3	14.0	UCSPA208CS6	UCSPA208CDS6	69	2 23/32	1.5	UCSPA208VCS6	UCSPA208VCDS6	98	3 55/64	1.5		
35 1 1/4 1 5/16 1 3/8	1 7/8	4 11/32	1 1/2	3 5/32	M14x2	1/2	3 19/32	25/32	1 3/16	1.689	0.689	UCSPA209-26S6 UCSPA209-27S6 UCSPA209-28S6 UCSPA209S6	SPA209	UC209-26S6 UC209-27S6 UC209-28S6 UC209S6	1.82	27.8	16.2	14.0	UCSPA209CS6	UCSPA209CDS6	69	2 23/32	1.82	UCSPA209VCS6	UCSPA209VCDS6	107	4 7/32	1.82		
40 1 1/2 1 9/16	1 15/16	4 9/16	1 9/16	3 5/16	M14x2	1/2	3 13/16	25/32	1 1/4	1.937	0.748	UCSPA210-30S6 UCSPA210-31S6 UCSPA210S6 UCSPA210-32S6	SPA210	UC210-30S6 UC210-31S6 UC210S6 UC210-32S6	2.26	29.8	18.6	14.4	UCSPA210CS6	UCSPA210CDS6	74	2 29/32	2.26	UCSPA210VCS6	UCSPA210VCDS6	120	4 23/32	2.26		

Remarks 1. In Part No. of unit and units with covers, fitting codes follow bore diameter numbers.
2. Part No. of applicable grease fitting is A-1/4-28UNFN13.
3. For the dimensions and forms of applicable bearings, see the dimensional tables of ball bearing for unit.

USP-S6
Cylindrical bore (with set screws)
 d 10 ~ 30 mm

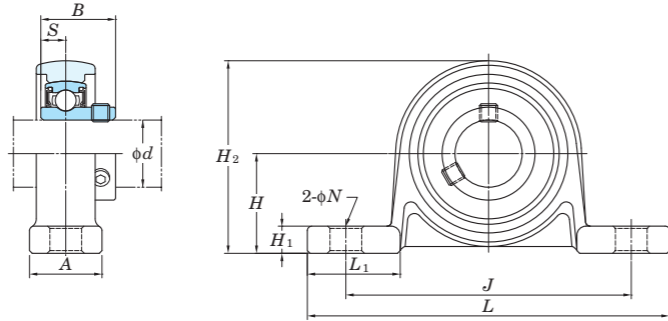

With Through Type Cover

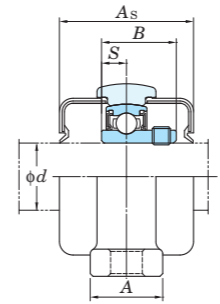

With One Side Sealed Cover

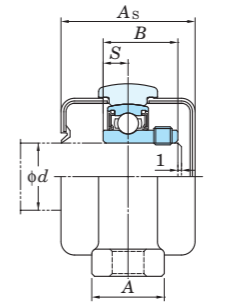

Variations of tolerance of distance from mounting bottom to center of spherical bore (ΔH_s) and variations of tolerance of distance between centers of bolt holes (ΔJ_s)

Housing No.	ΔH_s	ΔJ_s
SP000~SP006	± 0.15	± 0.4

Unit: mm

Shaft Dia. mm d	Dimensions inch mm										Bolt Size inch mm	Standard			Mass kg	Basic Load Ratings kN		Factor f_0	With Rubber Coated Cover			
	H	L	A	J	N	H_1	H_2	L_1	B	S		Unit No.	Housing No.	Bearing No.		C_r	C_{0r}		Unit No. Open Type	Unit No. One Side Closed Type	Dimension mm A_s	Dimension inch
10	$45/64$	$2\ 5/8$	$5/8$	$2\ 3/32$	$9/32$	$3/16$	$1\ 3/8$	$23/32$	0.591	0.197	$1/4$	USP000S6	SP000	SU000S6	3.9	1.55	12.3	USP000CS6	USP000CDS6	29	$1\ 5/32$	0.08
	18	67	16	53	7	5	35	18	15	5	M6										29	
12	$3/4$	$2\ 25/32$	$5/8$	$2\ 7/32$	$9/32$	$3/16$	$1\ 15/32$	$23/32$	0.591	0.197	$1/4$	USP001S6	SP001	SU001S6	4.3	1.9	13.2	USP001CS6	USP001CDS6	29	$1\ 5/32$	0.08
	19	71	16	56	7	5	37	18.5	15	5	M6										29	
15	$55/64$	$3\ 5/32$	$5/8$	$2\ 15/32$	$9/32$	$1/4$	$1\ 11/16$	$13/16$	0.650	0.217	$1/4$	USP002S6	SP002	SU002S6	4.7	2.25	13.9	USP002CS6	USP002CDS6	31	$1\ 7/32$	0.11
	22	80	16	63	7	6	42.5	20.5	16.5	5.5	M6										31	
17	$15/16$	$3\ 11/32$	$23/32$	$2\ 5/8$	$9/32$	$1/4$	$1\ 13/16$	$13/16$	0.689	0.236	$1/4$	USP003S6	SP003	SU003S6	5.1	2.6	14.4	USP003CS6	USP003CDS6	33	$1\ 5/16$	0.14
	24	85	18	67	7	6	46	21	17.5	6	M6										33	
20	$1\ 7/64$	$3\ 15/16$	$25/32$	$3\ 5/32$	$13/32$	$5/16$	$2\ 5/32$	$31/32$	0.827	0.276	$5/16$	USP004S6	SP004	SU004S6	7.9	4	13.9	USP004CS6	USP004CDS6	38	$1\ 1/2$	0.23
	28	100	20	80	10	8	54.5	25	21	7	M8										38	
25	$1\ 17/64$	$4\ 13/32$	$25/32$	$3\ 17/32$	$13/32$	$11/32$	$2\ 13/32$	$1\ 3/32$	0.866	0.276	$5/16$	USP005S6	SP005	SU005S6	8.5	4.65	14.5	USP005CS6	USP005CDS6	40	$1\ 9/16$	0.28
	32	112	20	90	10	9	61	27.5	22	7	M8										40	
30	$1\ 27/64$	$5\ 3/16$	$1\ 1/32$	$4\ 3/16$	$1/2$	$13/32$	$2\ 23/32$	$1\ 11/32$	0.965	0.295	$3/8$	USP006S6	SP006	SU006S6	11.2	6.6	14.7	USP006CS6	USP006CDS6	44	$1\ 23/32$	0.43
	36	132	26	106	13	10	69	34	24.5	7.5	M10										44	

Remarks 1. In Part No. of unit and units with covers, fitting codes follow bore diameter numbers.
2. For the dimensions and forms of applicable bearings, see the dimensional tables of ball bearing for unit.

UCSF-S6
Cylindrical bore (with set screws)
d 20 ~ 65 mm

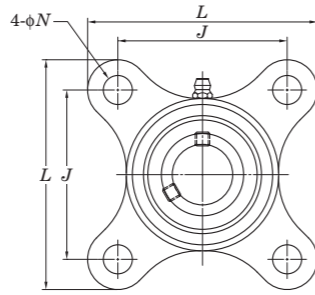
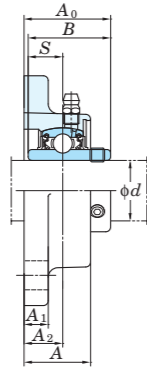

With Pressed Stainless Steel Cover

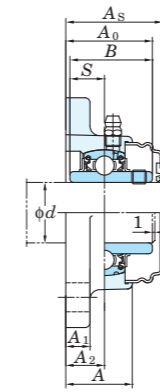

With Plastic Cover

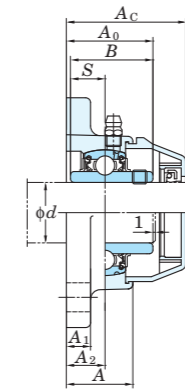

Variations of tolerance of distance from mounting surface to center of spherical bore (ΔA_{2s}) and tolerance of position of bolt hole (X)

Housing No.	ΔA_{2s}	X
SF204~SF210	± 0.5	0.7
SF211~SF213	± 0.8	1

Variations of tolerance of bolt hole diameter (ΔN_s)

Housing No.	ΔN_s
SF204~SF213	± 0.2

Shaft Dia mm inch d	Dimensions inch mm										Bolt Size inch mm	Unit No.	Standard		Mass kg	Basic Load Ratings			With Pressed Stainless Steel Cover				With Plastic Cover											
	L	A	J	N	A ₁	A ₂	A ₀	B	S	Housing No.			Bearing No.	C _r		C _{0r}	f ₀	Unit No.	Dimension mm	Dimension inch	Mass kg	Unit No.	Dimension mm	Dimension inch	Mass kg									
20 3/4	3 3/8	1 1/32	2 33/64	15/32	13/32	19/32	1 5/16	1.220	0.500	3/8	UCSF204-12S6	SF204	UC204-12S6	0.53	10.9	5.35	13.2	-	-	-	-	-	-	-	-	-	-	-	-	-	-	-	-	-
	86	26	64	12	10	15	33.3	31	12.7	M10	UCSF204S6		UC204S6					UCSF204CS6	UCSF204DS6	38	1 1/2	0.53	UCSF204VCS6	UCSF204VDS6	46	1 13/16	0.53							
25 7/8 15/16 1	3 3/4	1 3/32	2 3/4	15/32	13/32	5/8	1 13/32	1.343	0.563	3/8	UCSF205-14S6		UC205-14S6					-	-	-	-	-	-	-	-	-	-	-	-	-	-	-		
	95	27.5	70	12	10	16	35.8	34.1	14.3	M10	UCSF205-15S6	SF205	UC205-15S6	0.68	11.9	6.3	13.9	UCSF205CS6	UCSF205DS6	40	1 9/16	0.68	UCSF205VCS6	UCSF205VDS6	49.5	1 61/64	0.68							
30 1 1/8 1 3/16 1 1/4	4 1/4	1 7/32	3 17/64	15/32	13/32	45/64	1 19/32	1.500	0.626	3/8	UCSF206-18S6		UC206-18S6					-	-	-	-	-	-	-	-	-	-	-	-	-	-	-	-	
	108	31	83	12	10	18	40.2	38.1	15.9	M10	UCSF206S6	SF206	UC206S6	1.02	16.5	9.05	13.9	UCSF206CS6	UCSF206DS6	45	1 25/32	1.02	UCSF206VCS6	UCSF206VDS6	58	2 9/32	1.02							
35 1 1/4 1 5/16 1 3/8	4 19/32	1 11/32	3 5/8	35/64	7/16	3/4	1 3/4	1.689	0.689	7/16	UCSF207-20S6		UC207-20S6					-	-	-	-	-	-	-	-	-	-	-	-	-	-	-	-	
	117	34	92	14	11	19	44.4	42.9	17.5	M12	UCSF207-21S6	SF207	UC207-21S6	1.3	21.8	12.3	13.9	UCSF207CS6	UCSF207DS6	49	1 15/16	1.30	UCSF207VCS6	UCSF207VDS6	62.5	2 15/32	1.30							
40 1 1/2 1 9/16	5 1/8	1 13/32	4 1/64	5/8	15/32	53/64	2 1/32	1.937	0.748	1/2	UCSF207-23S6		UC207-23S6					-	-	-	-	-	-	-	-	-	-	-	-	-	-	-	-	
	130	36	102	16	12	21	51.2	49.2	19	M14	UCSF208-24S6	SF208	UC208-24S6	1.63	24.8	14.3	14.0	UCSF208CS6	UCSF208DS6	56	2 7/32	1.63	UCSF208VCS6	UCSF208VDS6	70	2 3/4	1.63							
45 1 5/8 1 11/16 1 3/4	5 13/32	1 1/2	4 9/64	5/8	1/2	55/64	2 1/16	1.937	0.748	1/2	UCSF208-25S6		UC208-25S6					-	-	-	-	-	-	-	-	-	-	-	-	-	-	-	-	
	137	38	105	16	13	22	52.2	49.2	19	M14	UCSF209-26S6	SF209	UC209-26S6	1.92	27.8	16.2	14.0	UCSF209CS6	UCSF209DS6	57	2 1/4	1.92	UCSF209VCS6	UCSF209VDS6	75.5	2 31/32	1.92							
50 1 7/8 1 15/16 2	5 5/8	1 9/16	4 3/8	5/8	1/2	55/64	2 5/32	2.031	0.748	1/2	UCSF209-27S6		UC209-27S6					-	-	-	-	-	-	-	-	-	-	-	-	-	-	-	-	
	143	40	111	16	13	22	54.6	51.6	19	M14	UCSF209-28S6	SF210	UC209-28S6	2.18	29.8	18.6	14.4	UCSF210CS6	UCSF210DS6	59	2 5/16	2.18	UCSF210VCS6	UCSF210VDS6	82	3 15/64	2.18							
55 2 2 1/8 2 3/16	6 3/8	1 11/16	5 1/8	3/4	19/32	63/64	2 5/16	2.189	0.874	5/8	UCSF210-30S6		UC210-30S6					-	-	-	-	-	-	-	-	-	-	-	-	-	-	-		
	162	43	130	19	15	25	58.4	55.6	22.2	M16	UCSF210-31S6	SF211	UC210-31S6	3.01	36.8	23.5	14.4	UCSF211CS6	UCSF211DS6	63	2 15/32	3.01	UCSF211VCS6	UCSF211VDS6	89.5	3 17/32	3.01							
60 2 1/4 2 3/8 2 7/16	6 7/8	1 7/8	5 5/8	3/4	19/32	1 9/64	2 23/32	2.563	1.000	5/8	UCSF211-32S6		UC211-32S6					-	-	-	-	-	-	-	-	-	-	-	-	-	-	-		
	175	48	143	19	15	29	68.7	65.1	25.4	M16	UCSF211-34S6	SF212	UC211-34S6	3.82	44.5	29	14.4	UCSF212CS6	UCSF212DS6	73	2 7/8	3.82	UCSF212VCS6	UCSF212VDS6	99	3 57/64	3.82							
65 2 1/2	7 23/64	1 31/32	5 7/8	3/4	45/64	1 3/16	2 3/4	2.563	1.000	5/8	UCSF211-35S6		UC211-35S6					-	-	-	-	-	-	-	-	-	-	-	-	-	-	-		
	187	50	149	19	18	30	69.7	65.1	25.4	M16	UCSF212-36S6	SF213	UC212-36S6	5.02	48.2	32.1	14.4	UCSF213CS6	UCSF213DS6	75	2 15/16	5.02	UCSF213VCS6	UCSF213VDS6	105	4 9/64	5.02							

Remarks 1. In Part No. of unit and units with covers, fitting codes follow bore diameter numbers.
2. Part No. of applicable grease fittings are shown below.
A-1/4-28UNFN13 204~210
A-R1/8N13 211~213
3. For the dimensions and forms of applicable bearings, see the dimensional tables of ball bearing for unit.

UCSF-ES6
Cylindrical bore (with set screws)
d 20 ~ 65 mm

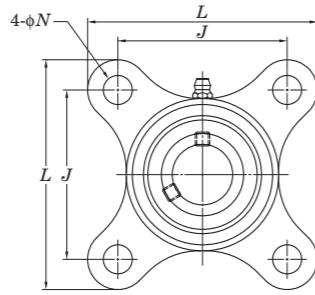
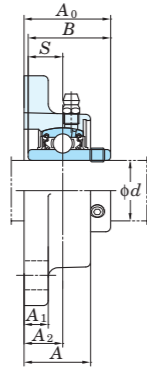

With Pressed Stainless Steel Cover

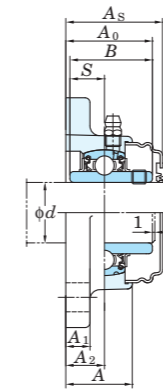

With Plastic Cover

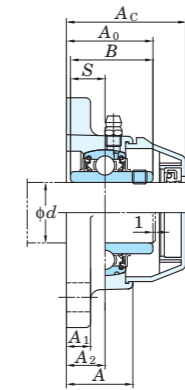

Variations of tolerance of distance from mounting surface to center of spherical bore (ΔA_{2s}) and tolerance of position of bolt hole (X)

Housing No.	ΔA_{2s}	X
SF204E~SF210E	± 0.5	0.7
SF211E~SF213E	± 0.8	1

Variations of tolerance of bolt hole diameter (ΔN_s)

Housing No.	ΔN_s
SF204E~SF213E	± 0.2

Shaft Dia mm inch <i>d</i>	Dimensions inch mm										Bolt Size inch mm	Unit No.	Standard Housing No.	Bearing No.	Mass kg	Basic Load Ratings			Factor f_0	With Pressed Stainless Steel Cover			With Plastic Cover											
	<i>L</i>	<i>A</i>	<i>J</i>	<i>N</i>	<i>A</i> ₁	<i>A</i> ₂	<i>A</i> ₀	<i>B</i>	<i>S</i>	Open Type						Closed Type	Dimension mm inch <i>A</i> _s	Mass kg		Open Type	Closed Type	Dimension mm inch <i>A</i> _c	Mass kg											
20 $\frac{3}{4}$	$3\frac{3}{8}$	$1\frac{1}{32}$	$2\frac{33}{64}$	$\frac{7}{16}$	$\frac{13}{32}$	$\frac{19}{32}$	$1\frac{5}{16}$	1.220	0.500	$\frac{3}{8}$	UCSF204-12ES6 UCSF204ES6	SF204E	UC204-12S6 UC204S6	0.53	10.9	5.35	13.2	-	-	-	-	-	-	-	-	-	-	-	-	-	-	-	-	
	$\frac{7}{8}$ $\frac{15}{16}$	$3\frac{3}{4}$	$1\frac{3}{32}$	$2\frac{3}{4}$	$\frac{29}{64}$	$\frac{13}{32}$	$\frac{5}{8}$	$1\frac{13}{32}$	1.343	0.563	$\frac{3}{8}$	UCSF205-14ES6 UCSF205-15ES6 UCSF205ES6 UCSF205-16ES6	SF205E	UC205-14S6 UC205-15S6 UC205S6 UC205-16S6	0.68	11.9	6.3	13.9	UCSF204ECS6	UCSF204EDS6	38	$1\frac{1}{2}$	0.53	UCSF204EVCS6	UCSF204EVD6	46	$1\frac{13}{16}$	0.53						
25 1	$3\frac{3}{4}$	$1\frac{3}{32}$	$2\frac{3}{4}$	$\frac{29}{64}$	$\frac{13}{32}$	$\frac{5}{8}$	$1\frac{13}{32}$	1.343	0.563	$\frac{3}{8}$	UCSF205-14ES6 UCSF205-15ES6 UCSF205ES6 UCSF205-16ES6	SF205E	UC205-14S6 UC205-15S6 UC205S6 UC205-16S6	0.68	11.9	6.3	13.9	UCSF205ECS6	UCSF205EDS6	40	$1\frac{9}{16}$	0.68	UCSF205EVCS6	UCSF205EVD6	49.5	$1\frac{61}{64}$	0.68							
	$1\frac{1}{8}$	$4\frac{1}{4}$	$1\frac{7}{32}$	$3\frac{17}{64}$	$\frac{33}{64}$	$\frac{13}{32}$	$\frac{45}{64}$	$1\frac{19}{32}$	1.500	0.626	$\frac{3}{8}$	UCSF206-18ES6 UCSF206ES6 UCSF206-19ES6 UCSF206-20ES6	SF206E	UC206-18S6 UC206S6 UC206-19S6 UC206-20S6	1.02	16.5	9.05	13.9	UCSF206ECS6	UCSF206EDS6	45	$1\frac{25}{32}$	1.02	UCSF206EVCS6	UCSF206EVD6	58	$2\frac{9}{32}$	1.02						
30 $1\frac{3}{16}$ $1\frac{1}{4}$	$4\frac{1}{4}$	$1\frac{7}{32}$	$3\frac{17}{64}$	$\frac{33}{64}$	$\frac{13}{32}$	$\frac{45}{64}$	$1\frac{19}{32}$	1.500	0.626	$\frac{3}{8}$	UCSF206-18ES6 UCSF206ES6 UCSF206-19ES6 UCSF206-20ES6	SF206E	UC206-18S6 UC206S6 UC206-19S6 UC206-20S6	1.02	16.5	9.05	13.9	-	-	-	-	-	-	-	-	-	-	-	-	-	-	-	-	
	$1\frac{1}{4}$ $1\frac{5}{16}$ $1\frac{3}{8}$	$4\frac{19}{32}$	$1\frac{11}{32}$	$3\frac{5}{8}$	$\frac{33}{64}$	$\frac{7}{16}$	$\frac{3}{4}$	$1\frac{3}{4}$	1.689	0.689	$\frac{7}{16}$	UCSF207-20ES6 UCSF207-21ES6 UCSF207-22ES6 UCSF207ES6 UCSF207-23ES6	SF207E	UC207-20S6 UC207-21S6 UC207-22S6 UC207S6 UC207-23S6	1.3	21.8	12.3	13.9	-	-	-	-	-	-	-	-	-	-	-	-	-	-	-	-
35 $1\frac{7}{16}$ $1\frac{1}{2}$ $1\frac{9}{16}$	$4\frac{19}{32}$	$1\frac{11}{32}$	$3\frac{5}{8}$	$\frac{33}{64}$	$\frac{7}{16}$	$\frac{3}{4}$	$1\frac{3}{4}$	1.689	0.689	$\frac{7}{16}$	UCSF207-20ES6 UCSF207-21ES6 UCSF207-22ES6 UCSF207ES6 UCSF207-23ES6	SF207E	UC207-20S6 UC207-21S6 UC207-22S6 UC207S6 UC207-23S6	1.3	21.8	12.3	13.9	UCSF207ECS6	UCSF207EDS6	49	$1\frac{15}{16}$	1.30	UCSF207EVCS6	UCSF207EVD6	62.5	$2\frac{15}{32}$	1.30							
	$1\frac{1}{2}$ $1\frac{9}{16}$	$5\frac{1}{8}$	$1\frac{13}{32}$	$4\frac{1}{64}$	$\frac{35}{64}$	$\frac{15}{32}$	$\frac{53}{64}$	$2\frac{1}{32}$	1.937	0.748	$\frac{1}{2}$	UCSF208-24ES6 UCSF208-25ES6 UCSF208ES6	SF208E	UC208-24S6 UC208-25S6 UC208S6	1.63	24.8	14.3	14.0	-	-	-	-	-	-	-	-	-	-	-	-	-	-	-	
40 $1\frac{1}{2}$ $1\frac{9}{16}$	$5\frac{1}{8}$	$1\frac{13}{32}$	$4\frac{1}{64}$	$\frac{35}{64}$	$\frac{15}{32}$	$\frac{53}{64}$	$2\frac{1}{32}$	1.937	0.748	$\frac{1}{2}$	UCSF208-24ES6 UCSF208-25ES6 UCSF208ES6	SF208E	UC208-24S6 UC208-25S6 UC208S6	1.63	24.8	14.3	14.0	UCSF208ECS6	UCSF208EDS6	56	$2\frac{7}{32}$	1.63	UCSF208EVCS6	UCSF208EVD6	70	$2\frac{3}{4}$	1.63							
	$1\frac{5}{8}$ $1\frac{11}{16}$ $1\frac{3}{4}$	$5\frac{13}{32}$	$1\frac{1}{2}$	$4\frac{9}{64}$	$\frac{5}{8}$	$\frac{1}{2}$	$\frac{55}{64}$	$2\frac{1}{16}$	1.937	0.748	$\frac{1}{2}$	UCSF209-26ES6 UCSF209-27ES6 UCSF209-28ES6 UCSF209ES6	SF209E	UC209-26S6 UC209-27S6 UC209-28S6 UC209S6	1.92	27.8	16.2	14.0	-	-	-	-	-	-	-	-	-	-	-	-	-	-	-	
45 $1\frac{5}{8}$ $1\frac{11}{16}$ $1\frac{3}{4}$	$5\frac{13}{32}$	$1\frac{1}{2}$	$4\frac{9}{64}$	$\frac{5}{8}$	$\frac{1}{2}$	$\frac{55}{64}$	$2\frac{1}{16}$	1.937	0.748	$\frac{1}{2}$	UCSF209-26ES6 UCSF209-27ES6 UCSF209-28ES6 UCSF209ES6	SF209E	UC209-26S6 UC209-27S6 UC209-28S6 UC209S6	1.92	27.8	16.2	14.0	UCSF209ECS6	UCSF209EDS6	57	$2\frac{1}{4}$	1.92	UCSF209EVCS6	UCSF209EVD6	75.5	$2\frac{31}{32}$	1.92							
	$1\frac{7}{8}$ $1\frac{15}{16}$	$5\frac{5}{8}$	$1\frac{9}{16}$	$4\frac{3}{8}$	$\frac{5}{8}$	$\frac{1}{2}$	$\frac{55}{64}$	$2\frac{5}{32}$	2.031	0.748	$\frac{1}{2}$	UCSF210-30ES6 UCSF210-31ES6 UCSF210ES6 UCSF210-32ES6	SF210E	UC210-30S6 UC210-31S6 UC210S6 UC210-32S6	2.18	29.8	18.6	14.4	-	-	-	-	-	-	-	-	-	-	-	-	-	-	-	
50 $1\frac{15}{16}$ 2	$5\frac{5}{8}$	$1\frac{9}{16}$	$4\frac{3}{8}$	$\frac{5}{8}$	$\frac{1}{2}$	$\frac{55}{64}$	$2\frac{5}{32}$	2.031	0.748	$\frac{1}{2}$	UCSF210-30ES6 UCSF210-31ES6 UCSF210ES6 UCSF210-32ES6	SF210E	UC210-30S6 UC210-31S6 UC210S6 UC210-32S6	2.18	29.8	18.6	14.4	UCSF210ECS6	UCSF210EDS6	59	$2\frac{5}{16}$	2.18	UCSF210EVCS6	UCSF210EVD6	82	$3\frac{15}{64}$	2.18							
	$2\frac{1}{8}$ $2\frac{3}{16}$	$6\frac{3}{8}$	$1\frac{11}{16}$	$5\frac{1}{8}$	$\frac{43}{64}$	$\frac{19}{32}$	$\frac{63}{64}$	$2\frac{5}{16}$	2.189	0.874	$\frac{5}{8}$	UCSF211-32ES6 UCSF211-34ES6 UCSF211ES6 UCSF211-35ES6	SF211E	UC211-32S6 UC211-34S6 UC211S6 UC211-35S6	3.01	36.8	23.5	14.4	-	-	-	-	-	-	-	-	-	-	-	-	-	-	-	
55 $2\frac{3}{16}$ $2\frac{1}{4}$	$6\frac{3}{8}$	$1\frac{11}{16}$	$5\frac{1}{8}$	$\frac{43}{64}$	$\frac{19}{32}$	$\frac{63}{64}$	$2\frac{5}{16}$	2.189	0.874	$\frac{5}{8}$	UCSF211-32ES6 UCSF211-34ES6 UCSF211ES6 UCSF211-35ES6	SF211E	UC211-32S6 UC211-34S6 UC211S6 UC211-35S6	3.01	36.8	23.5	14.4	UCSF211ECS6	UCSF211EDS6	63	$2\frac{15}{32}$	3.01	UCSF211EVCS6	UCSF211EVD6	89.5	$3\frac{17}{32}$	3.01							
	$2\frac{1}{4}$	$6\frac{7}{8}$	$1\frac{7}{8}$	$5\frac{5}{8}$	$\frac{43}{64}$	$\frac{19}{32}$	$1\frac{9}{64}$	$2\frac{23}{32}$	2.563	1.000	$\frac{5}{8}$	UCSF212-36ES6 UCSF212ES6 UCSF212-38ES6 UCSF212-39ES6	SF212E	UC212-36S6 UC212S6 UC212-38S6 UC212-39S6	3.82	44.5	29	14.4	UCSF212ECS6	UCSF212EDS6	73	$2\frac{7}{8}$	3.82	UCSF212EVCS6	UCSF212EVD6	99	$3\frac{57}{64}$	3.82						
60 $2\frac{3}{8}$ $2\frac{7}{16}$	$6\frac{7}{8}$	$1\frac{7}{8}$	$5\frac{5}{8}$	$\frac{43}{64}$	$\frac{19}{32}$	$1\frac{9}{64}$	$2\frac{23}{32}$	2.563	1.000	$\frac{5}{8}$	UCSF212-36ES6 UCSF212ES6 UCSF212-38ES6 UCSF212-39ES6	SF212E	UC212-36S6 UC212S6 UC212-38S6 UC212-39S6	3.82	44.5	29	14.4	-	-	-	-	-	-	-	-	-	-	-	-	-	-	-	-	
	$2\frac{1}{2}$	$7\frac{23}{64}$	$1\frac{31}{32}$	$5\frac{7}{8}$	$\frac{43}{64}$	$\frac{45}{64}$	$1\frac{3}{16}$	$2\frac{3}{4}$	2.563	1.000	$\frac{5}{8}$	UCSF213-40ES6 UCSF213ES6	SF213E	UC213-40S6 UC213S6	5.02	48.2	32.1	14.4	-	-	-	-	-	-	-	-	-	-	-	-	-	-		
65	$2\frac{1}{2}$	$7\frac{23}{64}$	$1\frac{31}{32}$	$5\frac{7}{8}$	$\frac{43}{64}$	$\frac{45}{64}$	$1\frac{3}{16}$	$2\frac{3}{4}$	2.563	1.000	$\frac{5}{8}$	UCSF213-40ES6 UCSF213ES6	SF213E	UC213-40S6 UC213S6	5.02	48.2	32.1	14.4	UCSF213ECS6	UCSF213EDS6	75	$2\frac{15}{16}$	5.02	UCSF213EVCS6	UCSF213EVD6	105	$4\frac{9}{64}$	5.02						

- Remarks
- In Part No. of unit and units with covers, fitting codes follow bore diameter numbers.
 - Part No. of applicable grease fittings are shown below.
A-1/4-28UNFN13 204~210
A-R1/8N13 211~213
 - For the dimensions and forms of applicable bearings, see the dimensional tables of ball bearing for unit.

UCSFL-S6
Cylindrical bore (with set screws)
d 12 ~ 50 mm

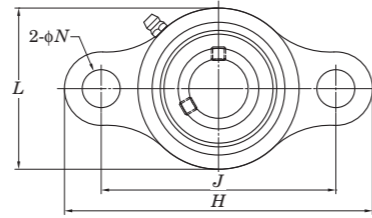
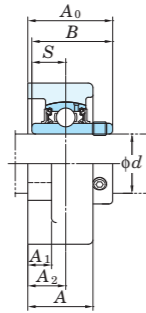

With Pressed Stainless Steel Cover

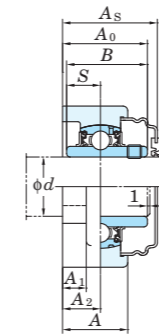

With Plastic Cover

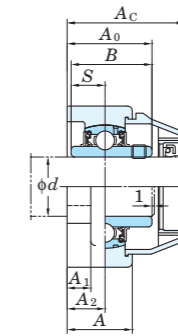

Variations of tolerance of distance from mounting surface to center of spherical bore (ΔA_{2s}) and variations of tolerance of distance between centers of bolt holes (ΔJ_s)

Housing No.	ΔA_{2s}	ΔJ_s
SFL203~SFL210	± 0.5	± 0.5

Variations of tolerance of bolt hole diameter (ΔN_s)

Housing No.	ΔN_s
SFL203~SFL210	± 0.2

Shaft Dia mm inch d	Dimensions inch mm										Bolt Size inch mm	Unit No.	Standard Housing No.	Bearing No.	Mass kg	Basic Load Ratings kN C_r C_{0r}	Factor f_0	With Pressed Stainless Steel Cover			With Plastic Cover									
	H	L	A	J	N	A ₁	A ₂	A ₀	B	S								Open Type	Closed Type	Dimension mm inch A _s	Mass kg	Open Type	Closed Type	Dimension mm inch A _c	Mass kg					
12 1/2	3 27/32	2 1/16	15/16	3	15/32	13/32	9/16	1 3/16	1.079	0.453	3/8	UCSFL201XS6 UCSFL201-8XS6 UCSFL202XS6 UCSFL202-10XS6 UCSFL203XS6	SFL203	UC201XS6 UC201-8XS6 UC202XS6 UC202-10XS6 UC203XS6	0.33	8.15	3.85	13.2	-	-	-	-	-	-	-	-	-	-	-	-
15 5/8	4 7/16	2 3/8	1 1/32	3 35/64	15/32	13/32	19/32	1 5/16	1.220	0.500	3/8	UCSFL204-12S6 UCSFL204S6	SFL204	UC204-12S6 UC204S6	0.47	10.9	5.35	13.2	UCSFL204CS6	UCSFL204DS6	38	1 1/2	0.47	UCSFL204VCS6	UCSFL204VDS6	46	1 13/16	0.47		
20 3/4	5 1/8	2 11/16	1 3/32	3 57/64	5/8	13/32	5/8	1 13/32	1.343	0.563	1/2	UCSFL205-14S6 UCSFL205-15S6 UCSFL205S6 UCSFL205-16S6	SFL205	UC205-14S6 UC205-15S6 UC205S6 UC205-16S6	0.61	11.9	6.30	13.9	UCSFL205CS6	UCSFL205DS6	40	1 9/16	0.61	UCSFL205VCS6	UCSFL205VDS6	49.5	1 61/64	0.61		
25 1	6 11/32	3 11/32	1 11/32	5 1/8	5/8	7/16	3/4	1 3/4	1.689	0.689	1/2	UCSFL206-18S6 UCSFL206S6 UCSFL206-19S6 UCSFL206-20S6	SFL206	UC206-18S6 UC206S6 UC206-19S6 UC206-20S6	0.9	16.5	9.05	13.9	UCSFL206CS6	UCSFL206DS6	45	1 15/32	0.9	UCSFL206VCS6	UCSFL206VDS6	58	2 9/32	0.9		
30 1 1/8	6 7/8	3 11/16	1 13/32	5 43/64	5/8	15/32	53/64	2 1/32	1.937	0.748	1/2	UCSFL207-20S6 UCSFL207-21S6 UCSFL207-22S6 UCSFL207S6 UCSFL207-23S6	SFL207	UC207-20S6 UC207-21S6 UC207-22S6 UC207S6 UC207-23S6	1.1	21.8	12.3	13.9	UCSFL207CS6	UCSFL207DS6	49	1 15/16	1.1	UCSFL207VCS6	UCSFL207VDS6	62.5	2 15/32	1.1		
35 1 1/4	7 13/32	3 15/16	1 1/2	5 53/64	3/4	1/2	55/64	2 1/16	1.937	0.748	1/2	UCSFL208-24S6 UCSFL208-25S6 UCSFL208S6	SFL208	UC208-24S6 UC208-25S6 UC208S6	1.4	24.8	14.3	14.0	UCSFL208CS6	UCSFL208DS6	56	2 7/32	1.4	UCSFL208VCS6	UCSFL208VDS6	70	2 3/4	1.4		
40 1 1/2	7 13/32	3 15/16	1 1/2	5 53/64	3/4	1/2	55/64	2 1/16	1.937	0.748	5/8	UCSFL209-26S6 UCSFL209-27S6 UCSFL209-28S6 UCSFL209S6	SFL209	UC209-26S6 UC209-27S6 UC209-28S6 UC209S6	1.6	27.8	16.2	14.0	UCSFL209CS6	UCSFL209DS6	57	2 7/32	1.6	UCSFL209VCS6	UCSFL209VDS6	75.5	2 31/32	1.6		
45 1 5/8	7 3/4	4 3/16	1 9/16	6 3/16	3/4	1/2	55/64	2 5/32	2.031	0.748	5/8	UCSFL210-30S6 UCSFL210-31S6 UCSFL210S6 UCSFL210-32S6	SFL210	UC210-30S6 UC210-31S6 UC210S6 UC210-32S6	1.9	29.8	18.6	14.4	UCSFL210CS6	UCSFL210DS6	59	2 9/16	1.9	UCSFL210VCS6	UCSFL210VDS6	82	3 15/64	1.9		

Remarks 1. In Part No. of unit and units with covers, fitting codes follow bore diameter numbers.
2. Part No. of applicable grease fitting is A-1/4-28UNFN13.
3. For the dimensions and forms of applicable bearings, see the dimensional tables of ball bearing for unit.

UCSFL-ES6
Cylindrical bore (with set screws)
d 12 ~ 50 mm

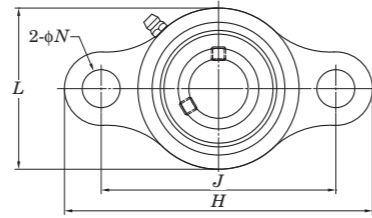
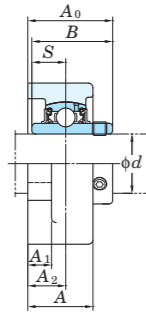

With Pressed Stainless Steel Cover

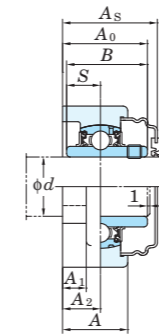

With Plastic Cover

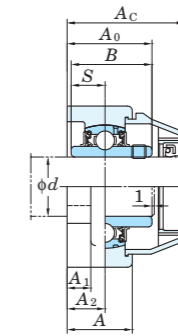

Variations of tolerance of distance from mounting surface to center of spherical bore (ΔA_{2s}) and variations of tolerance of distance between centers of bolt holes (ΔJ_s)

Housing No.	ΔA_{2s}	ΔJ_s
SFL203E~SFL210E	± 0.5	± 0.5

Variations of tolerance of bolt hole diameter (ΔN_s)

Housing No.	ΔN_s
SFL203E~SFL210E	± 0.2

Shaft Dia mm inch d	Dimensions inch mm										Bolt Size inch mm	Unit No.	Standard Housing No.	Bearing No.	Mass kg	Basic Load Ratings kN C_r C_{0r}	Factor f_0	With Pressed Stainless Steel Cover			With Plastic Cover										
	H	L	A	J	N	A ₁	A ₂	A ₀	B	S								Open Type Unit No.	Closed Type Unit No.	Dimension mm inch A _s	Mass kg	Open Type Unit No.	Closed Type Unit No.	Dimension mm inch A _c	Mass kg						
12 1/2	3 27/32	2 1/16	15/16	3	25/64	13/32	9/16	1 3/16	1.079	0.453	3/8	UCSFL201XES6 UCSFL201-8XES6 UCSFL202XES6 UCSFL202-10XES6 UCSFL203XES6	SFL203E	UC201XS6 UC201-8XS6 UC202XS6 UC202-10XS6 UC203XS6	0.33	8.15 3.85	13.2	-	-	-	-	-	-	-	-	-	-	-	-	-	-
15 5/8	4 7/16	2 3/8	1 1/32	3 35/64	25/64	13/32	19/32	1 5/16	1.220	0.500	3/8	UCSFL204-12ES6 UCSFL204ES6	SFL204E	UC204-12S6 UC204S6	0.47	10.9 5.35	13.2	UCSFL204ECS6	UCSFL204EDS6	38 1 1/2	0.47	UCSFL204EVCS6	UCSFL204EVD6	46 1 13/16	0.47	-	-	-	-	-	
20 3/4	5 1/8	2 11/16	1 3/32	3 57/64	15/32	13/32	5/8	1 13/32	1.343	0.563	1/2	UCSFL205-14ES6 UCSFL205-15ES6 UCSFL205ES6 UCSFL205-16ES6	SFL205E	UC205-14S6 UC205-15S6 UC205S6 UC205-16S6	0.61	11.9 6.30	13.9	UCSFL205ECS6	UCSFL205EDS6	40 1 9/16	0.61	UCSFL205EVCS6	UCSFL205EVD6	49.5 1 61/64	0.61	-	-	-	-	-	-
25 1	6 11/32	3 11/32	1 11/32	5 1/8	33/64	7/16	3/4	1 3/4	1.689	0.689	1/2	UCSFL206-18ES6 UCSFL206ES6 UCSFL206-19ES6 UCSFL206-20ES6	SFL206E	UC206-18S6 UC206S6 UC206-19S6 UC206-20S6	0.9	16.5 9.05	13.9	UCSFL206ECS6	UCSFL206EDS6	45 1 15/32	0.9	UCSFL206EVCS6	UCSFL206EVD6	58 2 9/32	0.9	-	-	-	-	-	
30 1 1/8	6 11/32	3 11/32	1 11/32	5 1/8	33/64	7/16	3/4	1 3/4	1.689	0.689	1/2	UCSFL207-20ES6 UCSFL207-21ES6 UCSFL207-22ES6 UCSFL207ES6 UCSFL207-23ES6	SFL207E	UC207-20S6 UC207-21S6 UC207-22S6 UC207S6 UC207-23S6	1.1	21.8 12.3	13.9	UCSFL207ECS6	UCSFL207EDS6	49 1 15/16	1.1	UCSFL207EVCS6	UCSFL207EVD6	62.5 2 15/32	1.1	-	-	-	-	-	
35 1 1/4	6 7/8	3 11/16	1 13/32	5 43/64	33/64	15/32	53/64	2 1/32	1.937	0.748	1/2	UCSFL208-24ES6 UCSFL208-25ES6 UCSFL208ES6	SFL208E	UC208-24S6 UC208-25S6 UC208S6	1.4	24.8 14.3	14.0	UCSFL208ECS6	UCSFL208EDS6	56 2 7/32	1.4	UCSFL208EVCS6	UCSFL208EVD6	70 2 3/4	1.4	-	-	-	-	-	
40 1 1/2	7 13/32	3 15/16	1 1/2	5 53/64	19/32	1/2	55/64	2 1/16	1.937	0.748	5/8	UCSFL209-26ES6 UCSFL209-27ES6 UCSFL209-28ES6 UCSFL209ES6	SFL209E	UC209-26S6 UC209-27S6 UC209-28S6 UC209S6	1.6	27.8 16.2	14.0	UCSFL209ECS6	UCSFL209EDS6	57 2 7/32	1.6	UCSFL209EVCS6	UCSFL209EVD6	75.5 2 31/32	1.6	-	-	-	-	-	
45 1 5/8	7 3/4	4 3/16	1 9/16	6 3/16	19/32	1/2	55/64	2 5/32	2.031	0.748	5/8	UCSFL210-30ES6 UCSFL210-31ES6 UCSFL210ES6 UCSFL210-32ES6	SFL210E	UC210-30S6 UC210-31S6 UC210S6 UC210-32S6	1.9	29.8 18.6	14.4	UCSFL210ECS6	UCSFL210EDS6	59 2 5/16	1.9	UCSFL210EVCS6	UCSFL210EVD6	82 3 15/64	1.9	-	-	-	-	-	

Remarks 1. In Part No. of unit and units with covers, fitting codes follow bore diameter numbers.
2. Part No. of applicable grease fitting is A-1/4-28UNFN13.
3. For the dimensions and forms of applicable bearings, see the dimensional tables of ball bearing for unit.

USFL-S6
Cylindrical bore (with set screws)
 d 10 ~ 30 mm

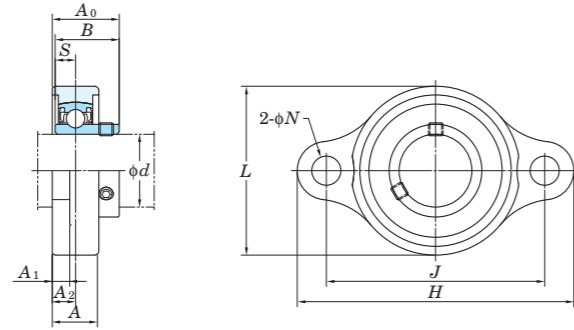

With Through Type Cover

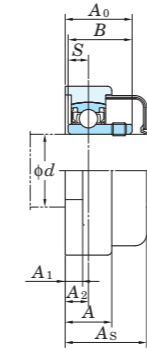

With One Side Sealed Cover

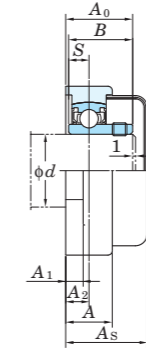

Variations of tolerance of distance from mounting surface to center of spherical bore (ΔA_{2s}) and variations of tolerance of distance between centers of bolt holes (ΔJ_s)

Housing No.	ΔA_{2s}	ΔJ_s
SFL000~SFL006	±0.5	±0.4

Unit: mm

Shaft Dia. mm d	Dimensions inch mm										Bolt Size inch mm	Standard			Mass kg	Basic Load Ratings kN		Factor f_0	With Rubber Coated Cover				
	H	L	A	J	N	A_1	A_2	A_0	B	S		Unit No.	Housing No.	Bearing No.		C_r	C_{0r}		Unit No. Open Type Closed Type	Dimension mm inch	Mass kg		
10	2 3/8	1 11/32	15/32	1 49/64	9/32	3/16	15/64	5/8	0.591	0.197	1/4	USFL000S6	SFL000	SU000S6	0.076	3.9	1.55	12.3	USFL000CS6	USFL000DS6	20.5	13/16	0.08
	60	34	12	45	7	5	6	16	15	5	M6												
12	2 15/32	1 13/32	15/32	1 57/64	9/32	3/16	15/64	5/8	0.591	0.197	1/4	USFL001S6	SFL001	SU001S6	0.080	4.3	1.9	13.2	USFL001CS6	USFL001DS6	20.5	13/16	0.08
	63	36	12	48	7	5	6	16	15	5	M6												
15	2 5/8	1 5/8	1/2	2 3/32	9/32	1/4	1/4	11/16	0.650	0.217	1/4	USFL002S6	SFL002	SU002S6	0.1	4.7	2.25	13.9	USFL002CS6	USFL002DS6	22	7/8	0.1
	67	41	13	53	7	6	6.5	17.5	16.5	5.5	M6												
17	2 25/32	1 23/32	9/16	2 13/64	9/32	1/4	9/32	23/32	0.689	0.236	1/4	USFL003S6	SFL003	SU003S6	0.13	5.1	2.6	14.4	USFL003CS6	USFL003DS6	23.5	15/16	0.13
	71	44	14	56	7	6	7	18.5	17.5	6	M6												
20	3 19/32	2 3/32	5/8	2 51/64	13/32	1/4	5/16	7/8	0.827	0.276	5/16	USFL004S6	SFL004	SU004S6	0.21	7.9	4	13.9	USFL004CS6	USFL004DS6	27	1 1/16	0.21
	91	53	16	71	10	6	8	22	21	7	M8												
25	3 3/4	2 9/32	5/8	2 61/64	13/32	1/4	5/16	29/32	0.866	0.276	5/16	USFL005S6	SFL005	SU005S6	0.23	8.5	4.65	14.5	USFL005CS6	USFL005DS6	28	1 3/32	0.23
	95	58	16	75	10	6	8	23	22	7	M8												
30	4 11/32	2 19/32	23/32	3 11/32	1/2	9/32	23/64	1 1/32	0.965	0.295	3/8	USFL006S6	SFL006	SU006S6	0.33	11.2	6.6	14.7	USFL006CS6	USFL006DS6	31	1 7/32	0.33
	110	66	18	85	13	7	9	26	24.5	7.5	M10												

Remarks 1. In Part No. of unit and units with covers, fitting codes follow bore diameter numbers.
2. For the dimensions and forms of applicable bearings, see the dimensional tables of ball bearing for unit.

UCSFC-S6
Cylindrical bore (with set screws)
d 20 ~ 40 mm

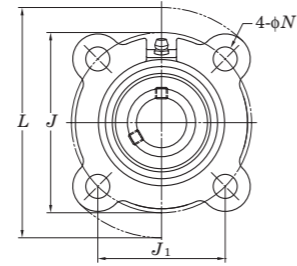
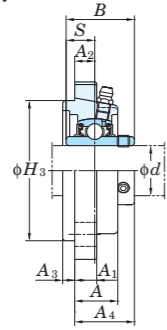

With Pressed Stainless Steel Cover

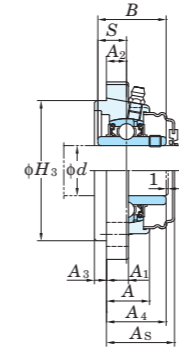

With Plastic Cover

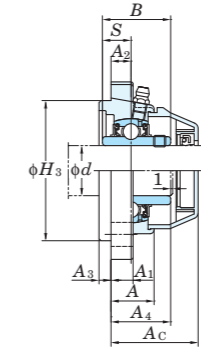

Variations of tolerance of spigot joint outside diameter (ΔH_{3s}), variations of tolerance of distance from mounting surface to center of spherical bore (ΔA_{2s}) and tolerance of position of bolt hole (X), and tolerance of circumferential runout of spigot joint (Y)

Housing No.	ΔH_{3s}	ΔA_{2s}	X	Y	Unit: mm
SFC204~SFC206	0 -0.046	±0.5	0.7	0.2	
SFC207~SFC208	0 -0.054				

Variations of tolerance of bolt hole diameter (ΔN_s)
Unit: mm

Housing No.	ΔN_s
SFC204~SFC208	±0.2

Shaft Dia mm inch d	Dimensions inch mm													Bolt Size inch mm	Standard			Mass kg	Basic Load Ratings kN		Factor f ₀	With Pressed Stainless Steel Cover				With Plastic Cover			
	L	H ₃	J	J ₁	N	A	A ₁	A ₂	A ₃	A ₄	B	S	Unit No.		Housing No.	Bearing No.	C _r		C _{0r}	Unit No. Open Type		Unit No. Closed Type	Dimension mm inch	Mass kg	Unit No. Open Type	Unit No. Closed Type	Dimension mm inch	Mass kg	
20 3/4	3 15/16	2.4409	3 5/64	2 11/64	15/32	13/16	25/64	25/64	13/64	1 1/8	1.220	0.500	3/8	UCSFC204-12S6	SFC204	UC204-12S6				-	-	-	-	-	-	-	-		
	100	62	78	55.1	12	21	10	10	5	28.3	31	12.7	M10	UCSFC204S6		UC204S6	0.54	10.9	5.35	13.2	UCSFC204CS6	UCSFC204DS6	32	1 1/4	0.54	UCSFC204VCS6	UCSFC204VDS6	41	1 17/32
25 7/8 1 15/16	4 17/32	2.7559	3 35/64	2 1/2	15/32	27/32	25/64	25/64	15/64	1 3/16	1.343	0.563	3/8	UCSFC205-14S6	SFC205	UC205-14S6				-	-	-	-	-	-	-	-		
	115	70	90	63.6	12	21.5	10	10	6	29.8	34.1	14.3	M10	UCSFC205-15S6		UC205-15S6	0.72	11.9	6.3	13.9	UCSFC205CS6	UCSFC205DS6	34	1 11/32	0.72	UCSFC205VCS6	UCSFC205VDS6	43.5	1 23/32
30 1 1/8 1 3/16 1 1/4	4 29/32	3.1496	3 15/16	2 25/32	15/32	29/32	25/64	25/64	5/16	1 9/32	1.500	0.626	3/8	UCSFC206-18S6	SFC206	UC206-18S6				-	-	-	-	-	-	-	-		
	125	80	100	70.7	12	23	10	10	8	32.2	38.1	15.9	M10	UCSFC206S6		UC206S6	0.92	16.5	9.05	13.9	UCSFC206CS6	UCSFC206DS6	36	1 13/32	0.92	UCSFC206VCS6	UCSFC206VDS6	50	1 31/32
35 1 1/4 1 5/16 1 3/8	5 5/16	3.5433	4 21/64	3 1/16	35/64	1 1/32	15/32	7/16	5/16	1 7/16	1.689	0.689	7/16	UCSFC207-20S6	SFC207	UC207-20S6				-	-	-	-	-	-	-	-		
	135	90	110	77.8	14	26	12	11	8	36.4	42.9	17.5	M12	UCSFC207-21S6		UC207-21S6	1.24	21.8	12.3	13.9	UCSFC207CS6	UCSFC207DS6	41	1 5/8	1.24	UCSFC207VCS6	UCSFC207VDS6	54.5	2 9/64
40 1 1/2 1 9/16	5 23/32	3.9370	4 23/32	3 11/32	35/64	1 1/32	15/32	7/16	25/64	1 5/8	1.937	0.748	7/16	UCSFC207-22S6	SFC207	UC207-22S6				-	-	-	-	-	-	-	-		
	145	100	120	84.8	14	26	12	11	10	41.2	49.2	19	M12	UCSFC207S6		UC207S6	1.56	24.8	14.3	14.0	UCSFC207CS6	UCSFC207DS6	41	1 5/8	1.24	UCSFC207VCS6	UCSFC207VDS6	54.5	2 9/64
40 1 1/2 1 9/16	5 23/32	3.9370	4 23/32	3 11/32	35/64	1 1/32	15/32	7/16	25/64	1 5/8	1.937	0.748	7/16	UCSFC208-24S6	SFC208	UC208-24S6				-	-	-	-	-	-	-	-		
	145	100	120	84.8	14	26	12	11	10	41.2	49.2	19	M12	UCSFC208-25S6		UC208-25S6	1.56	24.8	14.3	14.0	UCSFC208CS6	UCSFC208DS6	45	1 25/32	1.56	UCSFC208VCS6	UCSFC208VDS6	60	2 23/64

- Remarks
1. In Part No. of unit and units with covers, fitting codes follow bore diameter numbers.
 2. Part No. of applicable grease fitting is A-1/4-28UNFN13.
 3. For the dimensions and forms of applicable bearings, see the dimensional tables of ball bearing for unit.

UCST-S6
Cylindrical bore (with set screws)
d 20 ~ 50 mm

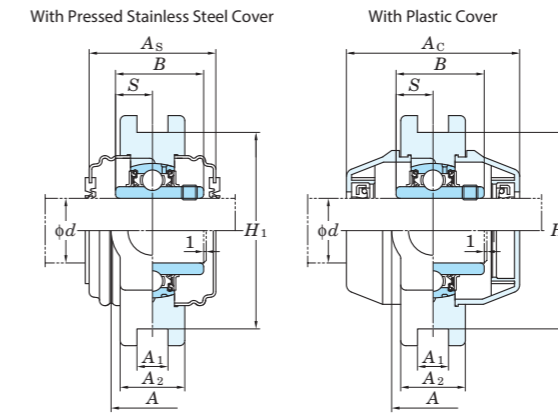
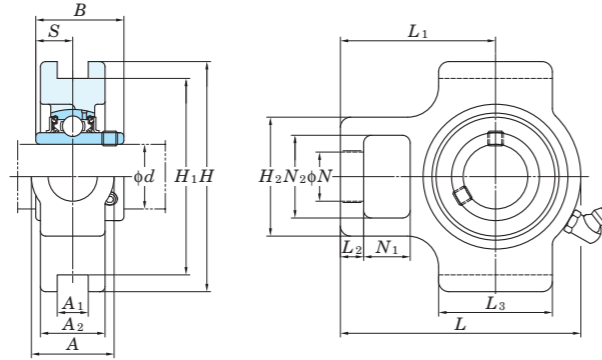

Variations of tolerance of groove width (Δ_{A1s}), variations of tolerance of distance between both grooves (Δ_{H1s}), and tolerance of symmetry of both groove sides (X)

Housing No.	Δ_{A1s}	Δ_{H1s}	X
ST204~ST210	+0.2 0	0 -0.5	0.5

Unit: mm

Shaft Dia. mm inch d	Dimensions inch mm															Standard			Mass kg	Basic Load Ratings kN		Factor f ₀	With Pressed Stainless Steel Cover				With Plastic Cover							
	A	A ₁	A ₂	H	H ₁	H ₂	L	L ₁	L ₂	L ₃	N	N ₁	N ₂	B	S	Unit No.	Housing No.	Bearing No.		Open Type	One Side Closed Type		Dimension mm inch	Mass kg	Open Type	One Side Closed Type	Dimension mm inch	Mass kg						
20 3/4	1 1/4	15/32	29/32	3 1/2	2 63/64	1 13/16	3 1/2	2 5/16	1 11/32	1 23/32	3/4	23/32	1 1/4	1.220	0.500	UCST204-12S6	ST204	UC204-12S6	-	-	-	-	-	-	-	-	UCST204CS6	UCST204CDS6	45 1 25/32	0.73	UCST204VCS6	UCST204VCD6	62 2 7/16	0.73
	32	12	23	89	76	46	89	59	9	44	19	18	32	31	12.7	UCST205-14S6	ST205	UC205-14S6	-	-	-	-	-	-	-	-	UCST205CS6	UCST205CDS6	49 1 15/16	0.79	UCST205VCS6	UCST205VCD6	68 2 43/64	0.79
25 7/8 15/16	1 1/4	15/32	31/32	3 1/2	2 63/64	1 13/16	3 21/32	2 3/8	1 11/32	1 23/32	3/4	23/32	1 1/4	1.343	0.563	UCST205-15S6	ST205	UC205-15S6	-	-	-	-	-	-	-	-	UCST205CS6	UCST205CDS6	49 1 15/16	0.79	UCST205VCS6	UCST205VCD6	68 2 43/64	0.79
	32	12	25	89	76	46	93	60	9	44	19	18	32	34.1	14.3	UCST206-18S6	ST206	UC206-18S6	-	-	-	-	-	-	-	-	UCST206CS6	UCST206CDS6	53 2 3/32	1.1	UCST206VCS6	UCST206VCD6	80 3 5/32	1.1
30 1 3/16 1 1/4	1 15/32	15/32	1 1/16	4 1/32	3 1/2	2 1/16	4 3/16	2 5/8	1 11/32	1 31/32	7/8	23/32	1 15/32	1.500	0.626	UCST206-19S6	ST206	UC206-19S6	-	-	-	-	-	-	-	-	UCST206CS6	UCST206CDS6	-	-	UCST206VCS6	UCST206VCD6	-	-
	37	12	27	102	89	52	106	67	9	50	22	18	37	38.1	15.9	UCST207-20S6	ST207	UC207-20S6	-	-	-	-	-	-	-	-	UCST207CS6	UCST207CDS6	60 2 3/8	1.5	UCST207VCS6	UCST207VCD6	87 3 27/64	1.5
35 1 1/4 1 5/16 1 3/8	1 15/32	15/32	1 7/32	4 1/32	3 1/2	2 7/32	4 11/16	2 15/16	7/16	2 7/32	7/8	23/32	1 15/32	1.689	0.689	UCST207-21S6	ST207	UC207-21S6	-	-	-	-	-	-	-	-	UCST207CS6	UCST207CDS6	60 2 3/8	1.5	UCST207VCS6	UCST207VCD6	87 3 27/64	1.5
	37	12	31	102	89	56	119	75	11	56	22	18	37	42.9	17.5	UCST208-24S6	ST208	UC208-24S6	-	-	-	-	-	-	-	-	UCST208CS6	UCST208CDS6	69 2 23/32	2.0	UCST208VCS6	UCST208VCD6	98 3 55/64	2.0
40 1 1/2 1 9/16	1 15/16	5/8	1 1/4	4 1/2	4 1/64	2 29/32	5 5/16	3 11/32	9/16	2 17/32	1 5/32	25/32	1 15/16	1.937	0.748	UCST209-26S6	ST209	UC209-26S6	-	-	-	-	-	-	-	-	UCST209CS6	UCST209CDS6	69 2 23/32	2.1	UCST209VCS6	UCST209VCD6	107 4 7/32	2.1
	49	16	32	114	102	74	135	85	14	64	29	20	49	49.2	19	UCST209-27S6	ST209	UC209-27S6	-	-	-	-	-	-	-	-	UCST209CS6	UCST209CDS6	69 2 23/32	2.1	UCST209VCS6	UCST209VCD6	107 4 7/32	2.1
45 1 11/16 1 3/4	1 15/16	5/8	1 11/32	4 19/32	4 1/64	2 29/32	5 13/32	3 11/32	9/16	2 19/32	1 5/32	25/32	1 15/16	1.937	0.748	UCST209-28S6	ST209	UC209-28S6	-	-	-	-	-	-	-	-	UCST209CS6	UCST209CDS6	69 2 23/32	2.1	UCST209VCS6	UCST209VCD6	107 4 7/32	2.1
	49	16	34	117	102	74	137	85	14	66	29	20	49	49.2	19	UCST210-30S6	ST210	UC210-30S6	-	-	-	-	-	-	-	-	UCST210CS6	UCST210CDS6	74 2 29/32	2.3	UCST210VCS6	UCST210VCD6	120 4 23/32	2.3
50 1 7/8 1 15/16	1 15/16	5/8	1 3/8	4 19/32	4 1/64	2 29/32	5 5/8	3 7/16	9/16	2 27/32	1 5/32	25/32	1 15/16	2.031	0.748	UCST210-31S6	ST210	UC210-31S6	-	-	-	-	-	-	-	-	UCST210CS6	UCST210CDS6	74 2 29/32	2.3	UCST210VCS6	UCST210VCD6	120 4 23/32	2.3
	49	16	35	117	102	74	143	87	14	72	29	20	49	51.6	19	UCST210-32S6	ST210	UC210-32S6	-	-	-	-	-	-	-	-	UCST210CS6	UCST210CDS6	74 2 29/32	2.3	UCST210VCS6	UCST210VCD6	120 4 23/32	2.3

Remarks 1. In Part No. of unit and units with covers, fitting codes follow bore diameter numbers.
2. Part No. of applicable grease fitting is B-1/4-28UNFN13.
3. For the dimensions and forms of applicable bearings, see the dimensional tables of ball bearing for unit.

UCST-ES6
Cylindrical bore (with set screws)
d 20 ~ 50 mm

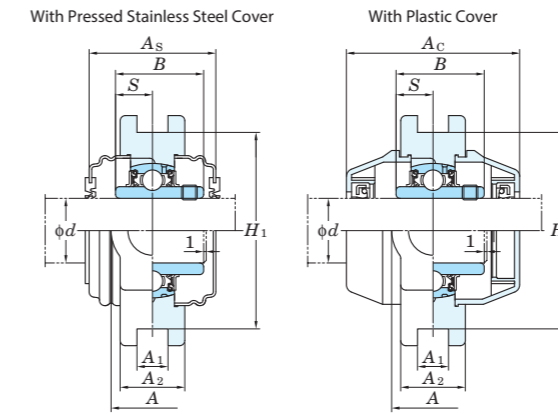
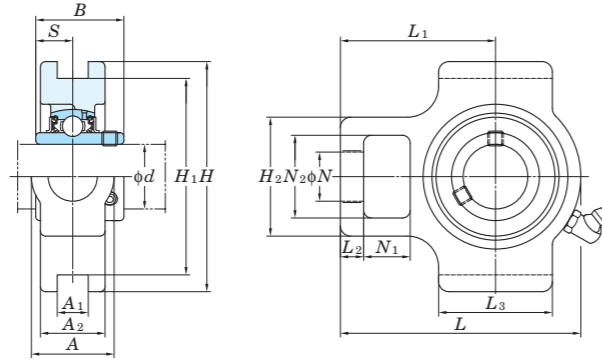

Variations of tolerance of groove width (Δ_{A1s}), variations of tolerance of distance between both grooves (Δ_{H1s}), and tolerance of symmetry of both groove sides (X)

Housing No.	Δ_{A1s}	Δ_{H1s}	X
ST204E~ST210E	+0.2 0	0 -0.5	0.5

Unit: mm

Shaft Dia. mm inch d	Dimensions inch mm															Standard			Mass kg	Basic Load Ratings kN		Factor f ₀	With Pressed Stainless Steel Cover				With Plastic Cover					
	A	A ₁	A ₂	H	H ₁	H ₂	L	L ₁	L ₂	L ₃	N	N ₁	N ₂	B	S	Unit No.	Housing No.	Bearing No.		C _r	C _{0r}		Unit No. Open Type	Unit No. One Side Closed Type	Dimension mm inch A _s	Mass kg	Unit No. Open Type	Unit No. One Side Closed Type	Dimension mm inch A _c	Mass kg		
20 3/4	1 1/4	17/32	29/32	3 1/2	3	1 13/16	3 1/2	2 5/16	11/32	1 23/32	3/4	23/32	1 1/4	1.220	0.500	UCST204-12ES6	ST204E	UC204-12S6			-	-	-	-	-	-	-	-	-	-		
	32	13.5	23	89	76.2	46	89	59	9	44	19	18	32	31	12.7	UCST204ES6		UC204S6	0.73	10.9	5.35	13.2	UCST204ECS6	UCST204ECD6S6	45	1 25/32	0.73	UCST204EVCS6	UCST204EVCDS6	62	2 7/16	0.73
25 7/8 15/16 1	1 1/4	17/32	31/32	3 1/2	3	1 13/16	3 21/32	2 3/8	11/32	1 23/32	3/4	23/32	1 1/4	1.343	0.563	UCST205-14ES6	ST205E	UC205-14S6			-	-	-	-	-	-	-	-	-	-	-	
	32	13.5	25	89	76.2	46	93	60	9	44	19	18	32	34.1	14.3	UCST205-15ES6		UC205-15S6	0.79	11.9	6.3	13.9	UCST205ECS6	UCST205ECD6S6	49	1 15/16	0.79	UCST205EVCS6	UCST205EVCDS6	68	2 43/64	0.79
																UCST205ES6		UC205S6														
																UCST205-16ES6		UC205-16S6														
30 1 1/8 1 3/16 1 1/4	1 15/32	17/32	1 1/16	4 1/32	3 1/2	2 1/16	4 3/16	2 5/8	11/32	1 31/32	7/8	23/32	1 15/32	1.500	0.626	UCST206-18ES6	ST206E	UC206-18S6			-	-	-	-	-	-	-	-	-	-	-	
	37	13.5	27	102	88.9	52	106	67	9	50	22	18	37	38.1	15.9	UCST206ES6		UC206S6	1.1	16.5	9.05	13.9	UCST206ECS6	UCST206ECD6S6	53	2 3/32	1.1	UCST206EVCS6	UCST206EVCDS6	80	3 5/32	1.1
																UCST206-19ES6		UC206-19S6														
																UCST206-20ES6		UC206-20S6														
35 1 1/4 1 5/16 1 3/8	1 15/32	17/32	1 7/32	4 1/32	3 1/2	2 7/32	4 11/16	2 15/16	7/16	2 7/32	7/8	23/32	1 15/32	1.689	0.689	UCST207-20ES6	ST207E	UC207-20S6			-	-	-	-	-	-	-	-	-	-	-	
	37	13.5	31	102	88.9	56	119	75	11	56	22	18	37	42.9	17.5	UCST207-21ES6		UC207-21S6	1.5	21.8	12.3	13.9	UCST207ECS6	UCST207ECD6S6	60	2 3/8	1.5	UCST207EVCS6	UCST207EVCDS6	87	3 27/64	1.5
																UCST207-22ES6		UC207-22S6														
																UCST207ES6		UC207S6														
40 1 1/2 1 9/16	1 15/16	11/16	1 1/4	4 1/2	4	2 29/32	5 5/16	3 11/32	9/16	2 17/32	1 5/32	25/32	1 15/16	1.937	0.748	UCST207-23ES6	ST207E	UC207-23S6			-	-	-	-	-	-	-	-	-	-	-	
	49	17.5	32	114	101.6	74	135	85	14	64	29	20	49	49.2	19	UCST208-24ES6		UC208-24S6	2	24.8	14.3	14.0	UCST208ECS6	UCST208ECD6S6	69	2 23/32	2.0	UCST208EVCS6	UCST208EVCDS6	98	3 55/64	2.0
																UCST208-25ES6	ST208E	UC208-25S6														
																UCST208ES6		UC208S6														
45 1 5/8 1 11/16 1 3/4	1 15/16	11/16	1 11/32	4 19/32	4	2 29/32	5 13/32	3 11/32	9/16	2 19/32	1 5/32	25/32	1 15/16	1.937	0.748	UCST209-26ES6	ST209E	UC209-26S6			-	-	-	-	-	-	-	-	-	-	-	
	49	17.5	34	117	101.6	74	137	85	14	66	29	20	49	49.2	19	UCST209-27ES6		UC209-27S6	2.1	27.8	16.2	14.0	UCST209ECS6	UCST209ECD6S6	69	2 23/32	2.1	UCST209EVCS6	UCST209EVCDS6	107	4 7/32	2.1
																UCST209-28ES6		UC209-28S6														
																UCST209ES6		UC209S6														
50 1 7/8 1 15/16 2	1 15/16	11/16	1 3/8	4 19/32	4	2 29/32	5 5/8	3 7/16	9/16	2 27/32	1 5/32	25/32	1 15/16	2.031	0.748	UCST210-30ES6	ST210E	UC210-30S6			-	-	-	-	-	-	-	-	-	-	-	
	49	17.5	35	117	101.6	74	143	87	14	72	29	20	49	51.6	19	UCST210-31ES6		UC210-31S6	2.3	29.8	18.6	14.4	UCST210ECS6	UCST210ECD6S6	74	2 29/32	2.3	UCST210EVCS6	UCST210EVCDS6	120	4 23/32	2.3
																UCST210ES6		UC210S6														
																UCST210-32ES6		UC210-32S6														

Remarks 1. In Part No. of unit and units with covers, fitting codes follow bore diameter numbers.
2. Part No. of applicable grease fitting is B-1/4-28UNFN13.
3. For the dimensions and forms of applicable bearings, see the dimensional tables of ball bearing for unit.

Ball Bearing Inserts

UC-S6, SU-S6 (Stainless steel series)
Cylindrical bore (with set screws)
d 10 ~ 65 mm



UC-S6



SU-S6

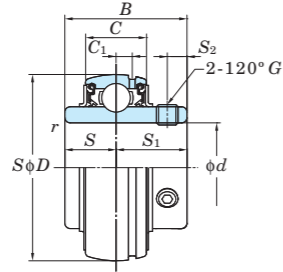

UC-S6

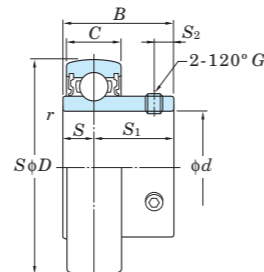

SU-S6

Shaft Dia. mm inch <i>d</i>	Dimensions								Basic Load Ratings kN		Factor	Bearing No. Standard	Dimensions								Set Screw Brg. Bore G mm	Mass kg
	<i>D</i>		<i>B</i>		<i>C</i>		r (min.)		<i>C_r</i>	<i>C_{0r}</i>	<i>f₀</i>		<i>C₁</i>	<i>S</i>		<i>S₁</i>		<i>S₂</i>				
	mm	inch	mm	inch	mm	inch	mm	inch				mm	inch	mm	inch	mm	inch	mm	inch			
10	26	1.024	15	0.591	8	0.315	0.3	0.012	3.9	1.55	12.3	SU000S6	5	0.197	10	0.394	3	0.118	M3x0.35	0.024		
12	28	1.102	15	0.591	8	0.315	0.3	0.012	4.3	1.9	13.2	SU001S6	5	0.197	10	0.394	3	0.118	M3x0.35	0.026		
	40	1.575	27.4	1.079	13	0.512	0.6	0.024	8.15	3.85	13.2	UC201XS6	3.5	0.138	11.5	0.453	15.9	0.626	4	0.158	M5x0.5	0.10
15	40	1.575	27.4	1.079	13	0.512	0.6	0.024	8.15	3.85	13.2	UC201-8XS6	3.5	0.138	11.5	0.453	15.9	0.626	4	0.158	M5x0.5	0.10
	32	1.260	16.5	0.650	9	0.354	0.3	0.012	4.7	2.25	13.9	SU002S6	5	0.197	11	0.433	3.3	0.130	M4x0.5	0.038		
17	40	1.575	27.4	1.079	13	0.512	0.6	0.024	8.15	3.85	13.2	UC202XS6	3.5	0.138	11.5	0.453	15.9	0.626	4	0.158	M5x0.5	0.10
	40	1.575	27.4	1.079	13	0.512	0.6	0.024	8.15	3.85	13.2	UC202-10S6	3.5	0.138	11.5	0.453	15.9	0.626	4	0.158	M5x0.5	0.10
20	35	1.378	17.5	0.689	10	0.394	0.3	0.012	5.1	2.6	14.4	SU003S6	6	0.236	11.5	0.453	3.3	0.130	M4x0.5	0.050		
	40	1.575	27.4	1.079	13	0.512	0.6	0.024	8.15	3.85	13.2	UC203XS6	3.5	0.138	11.5	0.453	15.9	0.626	4	0.158	M5x0.5	0.10
25	47	1.850	31	1.220	16	0.630	1	0.039	10.9	5.35	13.2	UC204-12S6	4	0.157	12.7	0.500	18.3	0.720	5	0.197	M6x0.75	0.16
	42	1.654	21	0.827	12	0.472	0.6	0.024	7.9	4	13.9	SU004S6	7	0.276	14	0.551	4	0.157	M5x0.5	0.080		
30	47	1.850	31	1.220	16	0.630	1	0.039	10.9	5.35	13.2	UC204S6	4	0.157	12.7	0.500	18.3	0.720	5	0.197	M6x0.75	0.16
	52	2.047	34.1	1.343	17	0.669	1	0.039	11.9	6.3	13.9	UC205-14S6	5	0.197	14.3	0.563	19.8	0.780	5.5	0.217	M6x0.75	0.23
35	52	2.047	34.1	1.343	17	0.669	1	0.039	11.9	6.3	13.9	UC205-15S6	5	0.197	14.3	0.563	19.8	0.780	5.5	0.217	M6x0.75	0.21
	47	1.850	22	0.866	12	0.472	0.6	0.024	8.5	4.65	14.5	SU005S6	7	0.276	15	0.591	4.5	0.177	M5x0.5	0.10		
40	52	2.047	34.1	1.343	17	0.669	1	0.039	11.9	6.3	13.9	UC205S6	5	0.197	14.3	0.563	19.8	0.780	5.5	0.217	M6x0.75	0.20
	52	2.047	34.1	1.343	17	0.669	1	0.039	11.9	6.3	13.9	UC205-16S6	5	0.197	14.3	0.563	19.8	0.780	5.5	0.217	M6x0.75	0.20
45	62	2.441	38.1	1.500	19	0.748	1	0.039	16.5	9.05	13.9	UC206-18S6	5	0.197	15.9	0.626	22.2	0.874	6	0.236	M6x0.75	0.34
	55	2.165	24.5	0.965	13	0.512	1	0.039	11.2	6.6	14.7	SU006S6	7	0.276	17	0.669	5.5	0.217	M5x0.5	0.15		
50	62	2.441	38.1	1.500	19	0.748	1	0.039	16.5	9.05	13.9	UC206S6	5	0.197	15.9	0.626	22.2	0.874	6	0.236	M6x0.75	0.32
	62	2.441	38.1	1.500	19	0.748	1	0.039	16.5	9.05	13.9	UC206-19S6	5	0.197	15.9	0.626	22.2	0.874	6	0.236	M6x0.75	0.32
55	62	2.441	38.1	1.500	19	0.748	1	0.039	16.5	9.05	13.9	UC206-20S6	5	0.197	15.9	0.626	22.2	0.874	6	0.236	M6x0.75	0.30
	72	2.835	42.9	1.689	20	0.787	1.1	0.043	21.8	12.3	13.9	UC207-20S6	5.5	0.217	17.5	0.689	25.4	1.000	6.5	0.256	M8x1	0.54
60	72	2.835	42.9	1.689	20	0.787	1.1	0.043	21.8	12.3	13.9	UC207-21S6	5.5	0.217	17.5	0.689	25.4	1.000	6.5	0.256	M8x1	0.51
	72	2.835	42.9	1.689	20	0.787	1.1	0.043	21.8	12.3	13.9	UC207-22S6	5.5	0.217	17.5	0.689	25.4	1.000	6.5	0.256	M8x1	0.48
65	72	2.835	42.9	1.689	20	0.787	1.1	0.043	21.8	12.3	13.9	UC207S6	5.5	0.217	17.5	0.689	25.4	1.000	6.5	0.256	M8x1	0.48
	72	2.835	42.9	1.689	20	0.787	1.1	0.043	21.8	12.3	13.9	UC207-23S6	5.5	0.217	17.5	0.689	25.4	1.000	6.5	0.256	M8x1	0.45
70	80	3.150	49.2	1.937	21	0.827	1.1	0.043	24.8	14.3	14.0	UC208-24S6	6	0.236	19	0.748	30.2	1.189	8	0.315	M8x1	0.68
	80	3.150	49.2	1.937	21	0.827	1.1	0.043	24.8	14.3	14.0	UC208-25S6	6	0.236	19	0.748	30.2	1.189	8	0.315	M8x1	0.60
75	80	3.150	49.2	1.937	21	0.827	1.1	0.043	24.8	14.3	14.0	UC208S6	6	0.236	19	0.748	30.2	1.189	8	0.315	M8x1	0.64
	85	3.346	49.2	1.937	22	0.866	1.1	0.043	27.8	16.2	14.0	UC209-26S6	6	0.236	19	0.748	30.2	1.189	8	0.315	M8x1	0.78
80	85	3.346	49.2	1.937	22	0.866	1.1	0.043	27.8	16.2	14.0	UC209-27S6	6	0.236	19	0.748	30.2	1.189	8	0.315	M8x1	0.74
	85	3.346	49.2	1.937	22	0.866	1.1	0.043	27.8	16.2	14.0	UC209-28S6	6	0.236	19	0.748	30.2	1.189	8	0.315	M8x1	0.70
85	85	3.346	49.2	1.937	22	0.866	1.1	0.043	27.8	16.2	14.0	UC209S6	6	0.236	19	0.748	30.2	1.189	8	0.315	M8x1	0.68
	90	3.543	51.6	2.031	24	0.945	1.1	0.043	29.8	18.6	14.4	UC210-30S6	6	0.236	19	0.748	32.6	1.283	9	0.354	M8x1	0.87
90	90	3.543	51.6	2.031	24	0.945	1.1	0.043	29.8	18.6	14.4	UC210-31S6	6	0.236	19	0.748	32.6	1.283	9	0.354	M8x1	0.82
	90	3.543	51.6	2.031	24	0.945	1.1	0.043	29.8	18.6	14.4	UC210S6	6	0.236	19	0.748	32.6	1.283	9	0.354	M8x1	0.80
95	90	3.543	51.6	2.031	24	0.945	1.1	0.043	29.8	18.6	14.4	UC210-32S6	6	0.236	19	0.748	32.6	1.283	9	0.354	M8x1	0.78
	100	3.937	55.6	2.189	25	0.984	1.5	0.059	36.8	23.5	14.4	UC211-32S6	7	0.276	22.2	0.874	33.4	1.315	9	0.354	M10x1.25	1.26
100	100	3.937	55.6	2.189	25	0.984	1.5	0.059	36.8	23.5	14.4	UC211-34S6	7	0.276	22.2	0.874	33.4	1.315	9	0.354	M10x1.25	1.15
	100	3.937	55.6	2.189	25	0.984	1.5	0.059	36.8	23.5	14.4	UC211S6	7	0.276	22.2	0.874	33.4	1.315	9	0.354	M10x1.25	1.11
105	100	3.937	55.6	2.189	25	0.984	1.5	0.059	36.8	23.5	14.4	UC211-35S6	7	0.276	22.2	0.874	33.4	1.315	9	0.354	M10x1.25	1.09
	110	4.331	65.1	2.563	27	1.063	1.5	0.059	44.5	29	14.4	UC212-36S6	7.5	0.295	25.4	1.000	39.7	1.563	10.5	0.413	M10x1.25	1.67
110	110	4.331	65.1	2.563	27	1.063	1.5	0.059	44.5	29	14.4	UC212S6	7.5	0.295	25.4	1.000	39.7	1.563	10.5	0.413	M10x1.25	1.54
	110	4.331	65.1	2.563	27	1.063	1.5	0.059	44.5	29	14.4	UC212-38S6	7.5	0.295	25.4	1.000	39.7	1.563	10.5	0.413	M10x1.25	1.52
115	110	4.331	65.1	2.563	27	1.063	1.5	0.059	44.5	29	14.4	UC212-39S6	7.5	0.295	25.4	1.000	39.7	1.563	10.5	0.413	M10x1.25	1.45
	120	4.724	65.1	2.563	28	1.102	1.5	0.059	48.6	32.1	14.4	UC213-40S6	7.5	0.295	25.4	1.000	39.7	1.563	12	0.472	M12x1.5	1.93
120	4.724	65.1	2.563	28	1.102	1.5	0.059	48.6	32.1	14.4	UC213S6	7.5	0.295	25.4	1.000	39.7	1.563	12	0.472	M12x1.5	1.86	

Remark S6 series product is the stainless steel series ball bearing for unit.

Smoother than ever. Water won't stay.



The redesigned shape and laser marked housings make the surface of our new stainless-steel housings smoother than ever. The flatter surface ensures there is no place for water to pool after washdown. The smooth housing and solid base reduce the risk of bacterial growth.

Our new stainless units accept both stainless and plastic covers. The plastic covers include a drain hole to allow any water that gets inside the cover to drain out. All our housings are casted using SUS316 grade stainless steel which is much more corrosion resistant than 304 stainless. All of our stainless inserts come packed with H1 food grade grease and are perfect for food and beverage applications. FYH utilizes our original Floback seal that offers multiple lip protection during washdown. FYH's new stainless series is designed to stand up to demanding applications such as food and beverage, pharmaceutical packaging, fertilizer applications and salt spreaders.

The laser marked QR code on the housings links to dimensional drawings and instructions on how to install the unit making it easy to install in the field.

FYH's new stainless series the only choice for your corrosion resistant bearing units.

WASHDOWN REDESIGNED

FYH

FYH INC.

2306 Hirao Miharaku Sakai Osaka 587-0022 JAPAN

TEL: 072-361-3750 FAX: 072-361-4173 E-mail: info@fyhbearings.com

FYH USA INC.

13201 FYH Drive, Huntley Illinois 60142 USA

TEL: 847-487-9111 FAX: 847-487-9222 E-mail: sales@fyhusa.com

FYH

